

Beastie Boy - 24" Industrial Fan Air Filter
by The 3D Handyman

Uses (6) 20x30x1in Air Filters - <https://amzn.to/3vSWQnW>

(1) 24" Industrial Fan - <https://amzn.to/37q96CV>

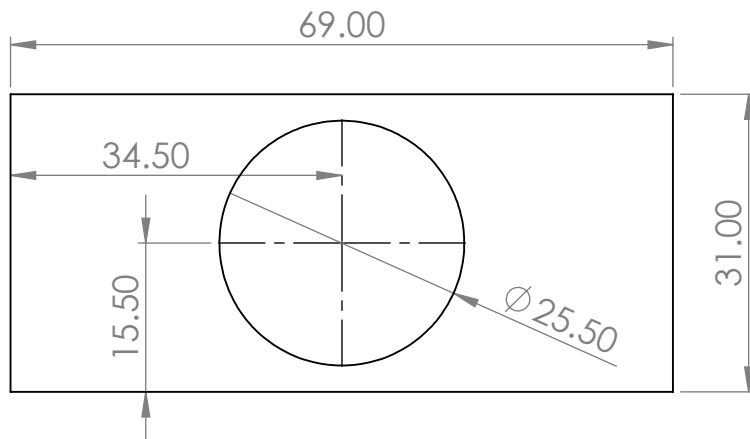

Top (1/2in plywood)

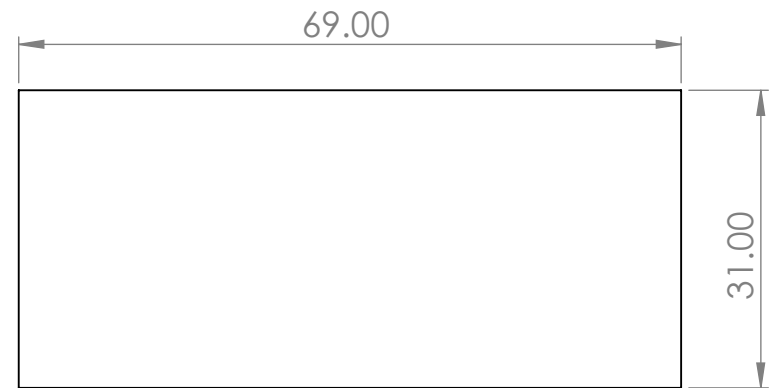

Bottom (1/4in or 1/2in plywood)

*Purchase Fan and double check diameter BEFORE cutting circle!

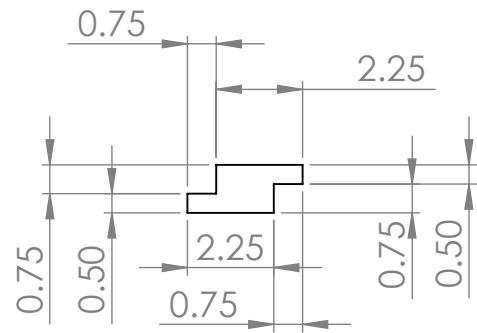
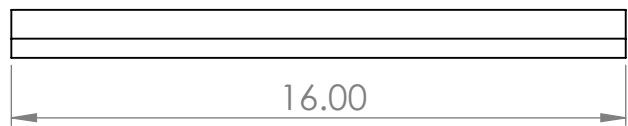
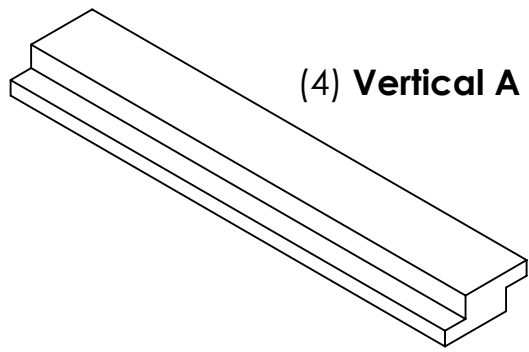
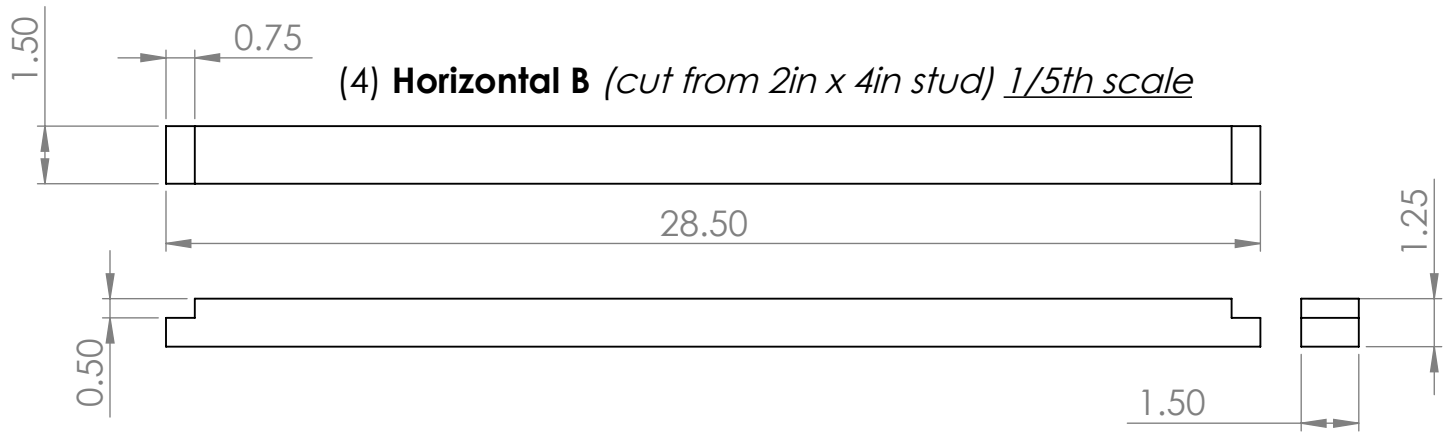
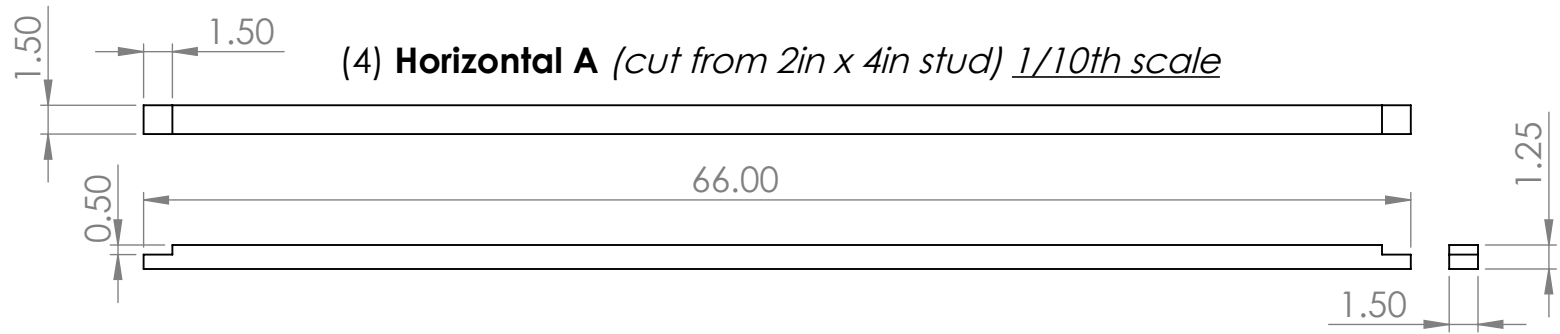

(2) **Vertical B**
(cut from 2in x 4in stud)

